

Complete Bar Buddy™ Sectionizer Model

Complete Sectionizer unit comes with Blade Cup of your choice, and corresponding Plunger.

Units Per Master Ctn.	Weight Per Master Ctn.	Suggested List Price
1	5	\$125.00

Complete Sectionizer Bar Model	Blade Cup Style	Description
B-201	4 Wedge	4 evenly spaced and cut wedges.
B-202	6 Wedge	6 evenly spaced and cut wedges.
B-203	6 Slice	6 Slices 5/16" thick (must use Plunger S-10).
B-204	8 Wedge	8 evenly spaced and cut wedges.
B-205	3-in-1	2 halves scored in 3 wedges each (for school foodservice).
B-207	Single	Cuts fruit & vegetables in half.

Basic Bar Buddy™ Sectionizer Model

B-200 – Basic Bar Buddy Sectionizer Unit
No Plunger and No Blade Cup

Units Per Master Ctn.	Weight Per Master Ctn.	Suggested List Price
1	5	\$100.00

Apple Sectionizer Model

B-206 – Apple Model
6 evenly spaced and cut wedges

Units Per Master Ctn.	Weight Per Master Ctn.	Suggested List Price
1	5	\$145.00

Tomato Sectionizer Model

B-209 – Serrated Blades - Tomato Model
7 evenly spaced and sliced - recommended for tomatoes, kiwis, mushrooms, strawberries and hardboiled eggs.

Units Per Master Ctn.	Weight Per Master Ctn.	Suggested List Price
1	5	\$140.00

Individual Parts – Optional

8 wedge, 6 wedge, 4 wedge, 3-in-1 and single wedge cups are interchangeable and use the same plunger. A wedger may be changed to a slicer or slicer to wedger by replacing cup, plunger and neoprene cup cover.
S-32 Apple Blade Cup can only be used with S-33 Apple Plunger.

Part Number	Parts Description	Cost
B-1	Container - 2.7 Quart	\$18.00
B-2	Lid - 2.7 Quart	5.00
B-3	2.7 Quart Assembly - Container & Lid (B-1 & B-2)	21.00
B-4	Cup Holder	40.00
B-5	Plunger Assembly	66.00
S-3B	Blade Cup w/cover (6 wedge) (fits S-9)	48.00
S-4B	Blade Cup w/cover (6 slice) (fits S-10)	62.00
S-5B	Blade Cup w/cover (4 wedge) (fits S-9)	46.00
S-6	Wedger Cup cover (sold w/S-3, S-5, S-29, S-30, S-32, S-35)	12.00
S-7	Slicer Cup cover (sold w/S-4)	12.00
S-9	Plunger Wedger (fits parts S-3, S-5, S-29, S-30, S-35)	24.00
S-10	Plunger Slicer fits part S-4 only	24.00
S-11C & D	Crossbar Assembly Screw Set	2.00
S-15	7 Slice serrated Blade Cup w/cover (fits S-16)	76.00
S-16	Plunger Tomato Slicer (fits S-15)	28.00
S-17	Tomato Set (S-15 & S-16)	98.00
S-29B	Blade Cup w/cover (8 wedge) (fits S-9)	50.00
S-30B	Blade Cup w/cover (3-in-1) (fits S-9)	56.00
S-32B	Apple Corer Cup (fits S-33)	84.00
S-33	Apple Plunger (fits S-32)	30.00
S-34	Apple Corer Set (S-32 & S-33)	100.00
S-35B	Single Blade Cup w/cover (fits S-9)	44.00









Additional Containers & Lids Available



B-3. 2.7 Quart Assembly – Container & Lid (B-1 & B-2)

Overall Dimensions7" high, 7" wide
Shipping Weight1½ pounds

Blade Cup Styles

	PLUNGER S-9 CUP S-5
4 Wedge	
	PLUNGER S-9 CUP S-3
6 Wedge	
	PLUNGER S-10 CUP S-4
6 Slice	
	PLUNGER S-9 CUP S-29
8 Wedge	
	PLUNGER S-9 CUP S-30
3-in-1	
	PLUNGER S-33 CUP S-32
Apple Model	
	PLUNGER S-9 CUP S-35
Single	
	PLUNGER S-16 CUP S-15
Tomato Model	

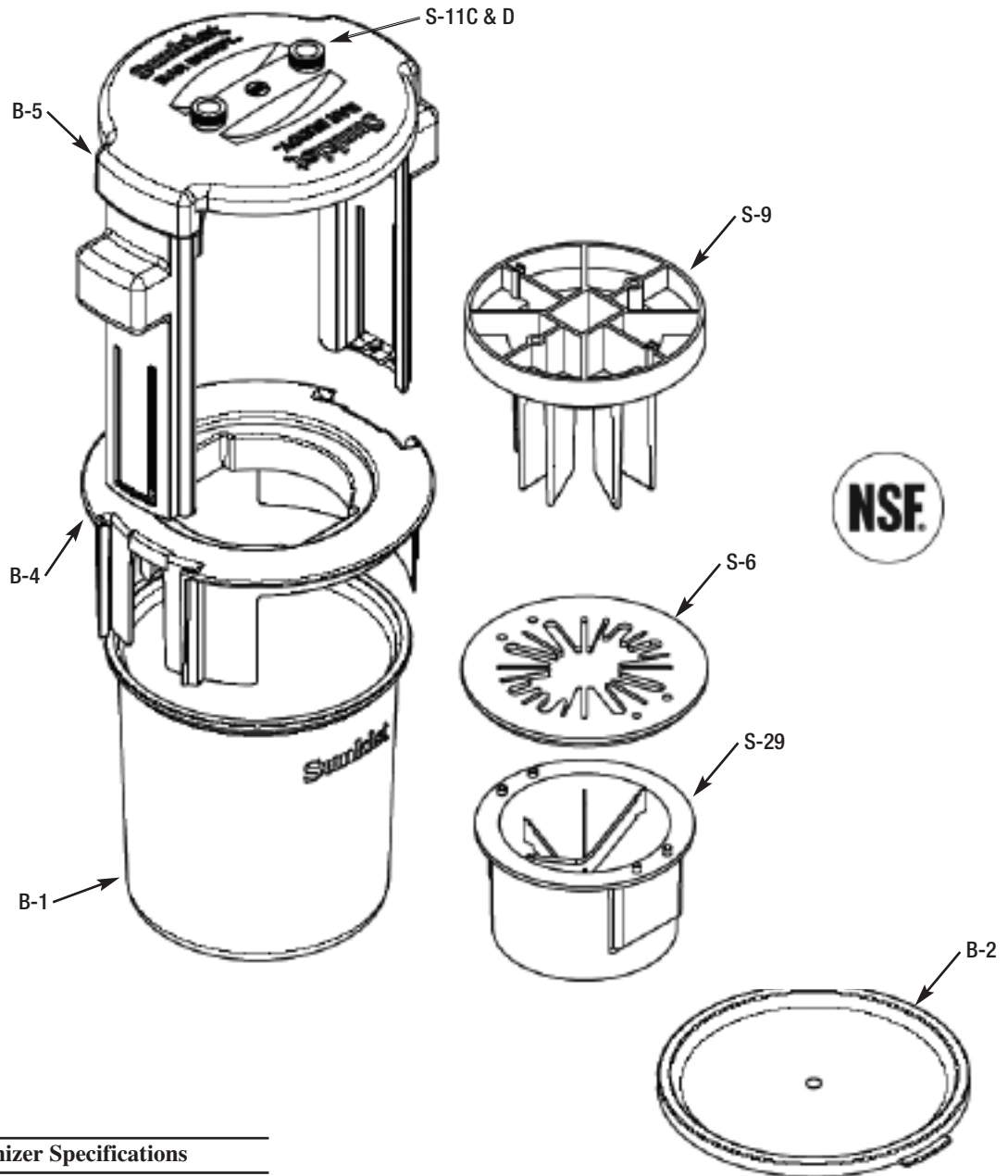

Complete Bar Buddy™ Sectionizer Specifications

Safe...Listed by NSF International.

Overall Dimensions9½" high, 9½" wide, 7¾" deep

Net Weight4 pounds

Shipping Weight5 pounds

Volume0.47 cu.ft.

Carton Size10" high, 10" wide, 8" deep

foodservice.sunkist.com/equipment

All prices quoted are FOB Fontana, CA and are subject to change without notice. These prices are also listed in AutoQuotes. The amount of any present or future tax shall be paid by the purchaser. There is **not** a minimum order fee for orders we drop ship to your customer, or for orders being sent to service centers for equipment waiting to be repaired. A service charge of \$10.00 will be added to all orders less than \$50.00 that are shipped to your location or one of your warehouses. CONTACT: Sunkist Foodservice Equipment Customer Service: (800) 383-7141 or (909) 933-5852. FAX orders to (909) 822-2125.

Products must not be returned without a return authorization number.